

Aluminum • Galvanized • Stainless

Punched Channel 2" Flange

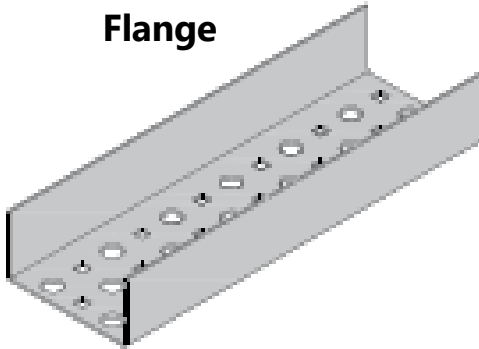

Round hole for 1/2" bolts.
Square hole for 1/4" carriage bolt or machine screw

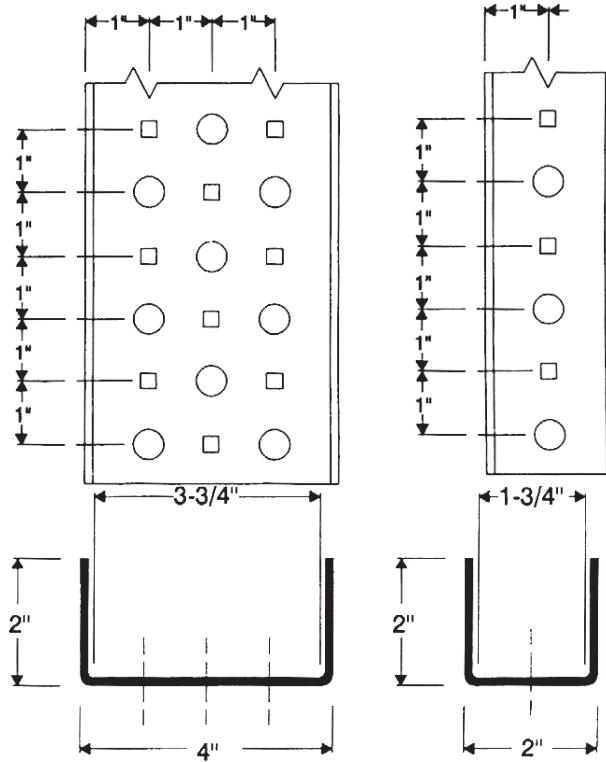
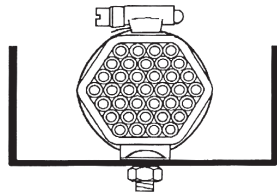

Lengths: 10 ft. & 20 ft.

Dimensions	Material	Part Number
2" X 2" X 1/8"	6063-T6 Aluminum	A200C200
2" X 2" X 12, 14 GA.	H.D.G.A.F. STEEL	HG200C200-(*)
2" X 2" X 12, 14, 16 GA.	304 S. S.	SS200C200-(*)4
2" X 2" X 12, 14, 16 GA.	316 S. S.	SS200C200-(*)6
4" X 2" X 1/8"	6063-T6 Aluminum	A400C200
4" X 2" X 12, 14 GA.	H.D.G.A.F. STEEL	HG400C200-(*)
4" X 2" X 12, 14, 16 GA.	304 S. S.	SS400C200-(*)4
4" X 2" X 12, 14, 16 GA.	316 S. S.	SS400C200-(*)6
6" X 2" X 1/8"	6063-T6 Aluminum	A600C200
6" X 2" X 12, 14 GA.	H.D.G.A.F. STEEL	HG600C200-(*)
6" X 2" X 12, 14, 16 GA.	304 S. S.	SS600C200-(*)4
6" X 2" X 12, 14, 16 GA.	316 S. S.	SS600C200-(*)6

Note: Insert 2 For (*) For 12 Gauge
Insert 4 For (*) For 14 Gauge
Insert 6 For (*) For 16 Gauge

Example: SS400C200-66
Denotes: 4" Wide X 2" Deep X 16 GA. X 316 S.S. Channel





Fittings: For 2" Deep Channel

Note: H.D.G.A.F. - hot-dipped galvanized after fabrication steel

Channel Connector

Channel Width	Aluminum	H.D.G.A.F.	Stainless
2"	A202CN	HG202CN	SS202CN
4"	A402CN	HG402CN	SS402CN
6"	A602CN	HG602CN	SS602CN

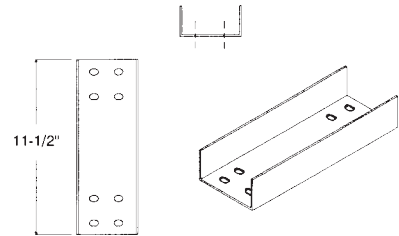

Channel Horizontal Tee - 3" Radius

Channel Width	Aluminum	H.D.G.A.F.	Stainless
2"	A202CHT	HG202CHT	SS202CHT
4"	A402CHT	HG402CHT	SS402CHT
6"	A602CHT	HG602CHT	SS602CHT

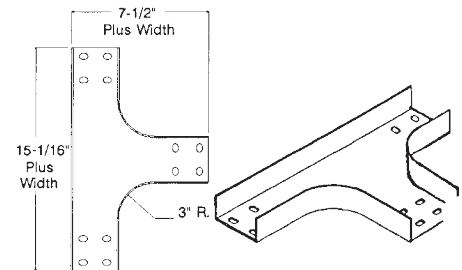

Channel Horizontal Cross - 3" Radius

Channel Width	Aluminum	H.D.G.A.F.	Stainless
2"	A202CHC	HG202CN	SS202CN
4"	A402CHC	HG402CN	SS402CN
6"	A602CHC	HG602CN	SS602CN

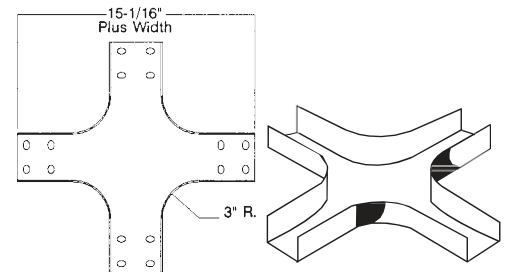

90° Channel Horizontal Elbow - 3" Radius

Channel Width	Aluminum	H.D.G.A.F.	Stainless
2"	A202CHE	HG202CHE	SS202CHE
4"	A402CHE	HG402CHE	SS402CHE
6"	A602CHE	HG602CHE	SS602CHE

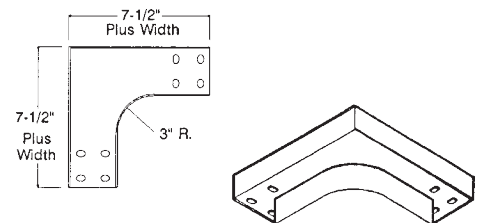

90° Channel Outside Vertical Elbow - 3" Radius

Channel Width	Aluminum	H.D.G.A.F.	Stainless
2"	A202COVE	HG202COVE	SS202COVE
4"	A402COVE	HG402COVE	SS402COVE
6"	A602COVE	HG602COVE	SS602COVE

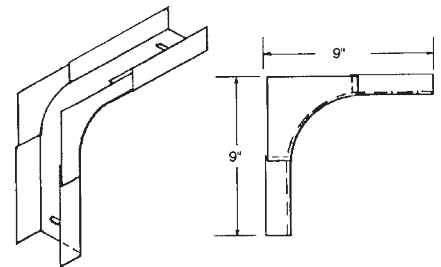



Fittings: For 2" Deep Channel

Note: All illustrations are for 4" wide channel

90° Channel Inside Vertical Elbow - 3" Radius

Channel Width	Aluminum	H.D.G.A.F.	Stainless
2"	A202CIVE	HG202CIVE	SS202CIVE
4"	A402CIVE	HG402CIVE	SS402CIVE
6"	A602CIVE	HG602CIVE	SS602CIVE

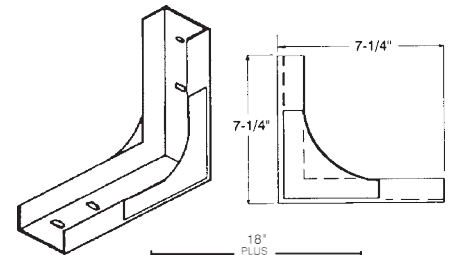

90° Channel Horizontal Elbow - 12" Radius

Channel Width	Aluminum	H.D.G.A.F.	Stainless
2"	A202CHE-12	HG202CHE-12	SS202CHE-12-4
4"	A402CHE-12	HG402CHE-12	SS402CHE-12-4
6"	A602CHE-12	HG602CHE-12	SS602CHE-12-4

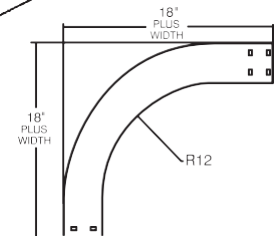

90° Channel Outside Vertical Elbow - 12" Radius

Channel Width	Aluminum	H.D.G.A.F.	Stainless
2"	A202COVE-12	HG202COVE-12	SS202COVE-12-4
4"	A402COVE-12	HG402COVE-12	SS402COVE-12-4
6"	A602COVE-12	HG602COVE-12	SS602COVE-12-4

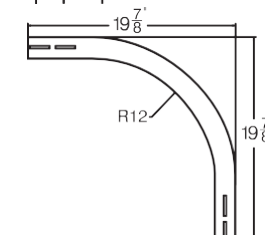

90° Channel Inside Vertical Elbow - 14" Radius

Channel Width	Aluminum	H.D.G.A.F.	Stainless
2"	A202CIVE-14	HG202CIVE-14	SS202CIVE-14-4
4"	A402CIVE-14	HG402CIVE-14	SS402CIVE-14-4
6"	A602CIVE-14	HG602CIVE-14	SS602CIVE-14-4

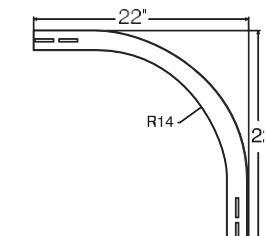

90° Channel Horizontal Tee - 12" Radius

Channel Width	Aluminum	H.D.G.A.F.	Stainless
2"	A202CHT-12	HG202CHT-12	SS202CHT-12-4
4"	A402CHT-12	HG402CHT-12	SS402CHT-12-4
6"	A602CHT-12	HG602CHT-12	SS602CHT-12-4

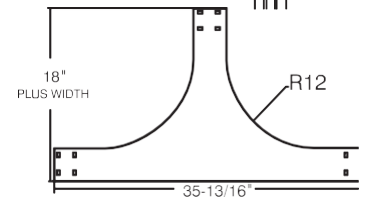

90° Channel Horizontal Cross - 12" Radius

Channel Width	Aluminum	H.D.G.A.F.	Stainless
2"	A202CHC-12	HG202CHC-12	SS202CHC-12-4
4"	A402CHC-12	HG402CHC-12	SS402CHC-12-4
6"	A602CHC-12	HG602CHC-12	SS602CHC-12-4

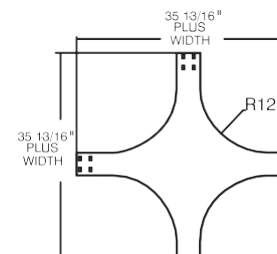



Aluminum • Galvanized • Stainless

Punched Channel 1" Flange

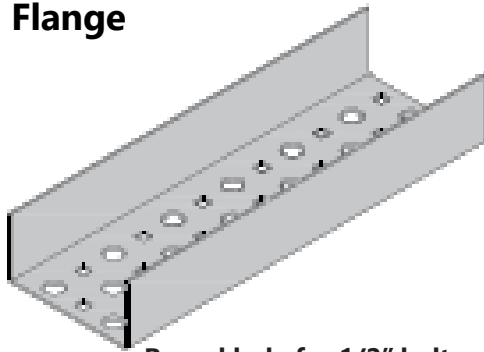

Round hole for 1/2" bolts.
Square hole for 1/4" carriage bolt or machine screw

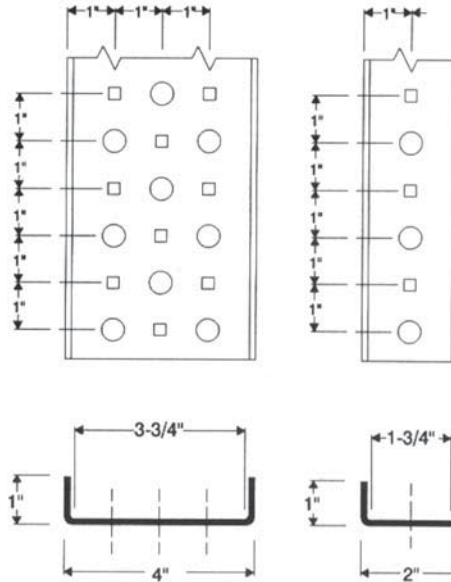
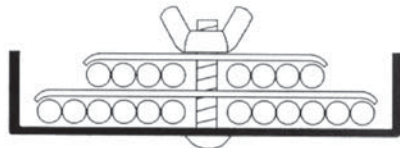

Lengths: 10 ft. & 20 ft.

Dimensions	Material	Part Number
1" X 1" X 1/8" 1" X 1" X 12, 14 GA. 1" X 1" X 12, 14, 16 GA. 1" X 1" X 12, 14, 16 GA.	6063-T6 Aluminum H.D.G.A.F. STEEL 304 S. S. 316 S. S.	A100C100 HG100C100-(* SS100C100-(*4 SS100C100-(*6
1.5" X 1" X 1/8" 1.5" X 1" X 12, 14 GA. 1.5" X 1" X 12, 14, 16 GA. 1.5" X 1" X 12, 14, 16 GA.	6063-T6 Aluminum H.D.G.A.F. STEEL 304 S. S. 316 S. S.	A150C100 HG150C100-(* SS150C100-(*4 SS150C100-(*6
2" X 1" X 1/8" 2" X 1" X 12, 14 GA. 2" X 1" X 12, 14, 16 GA. 2" X 1" X 12, 14, 16 GA.	6063-T6 Aluminum H.D.G.A.F. STEEL 304 S. S. 316 S. S.	A200C100 HG200C100-(* SS200C100-(*4 SS200C100-(*6
4" X 1" X 1/8" 4" X 1" X 12, 14 GA. 4" X 1" X 12, 14, 16 GA. 4" X 1" X 12, 14, 16 GA.	6063-T6 Aluminum H.D.G.A.F. STEEL 304 S. S. 316 S. S.	A400C100 HG400C100-(* SS400C100-(*4 SS400C100-(*6
6" X 1" X 1/8" 6" X 1" X 12, 14 GA. 6" X 1" X 12, 14, 16 GA. 6" X 1" X 12, 14, 16 GA.	6063-T6 Aluminum H.D.G.A.F. STEEL 304 S. S. 316 S. S.	A600C100 HG600C100-(* SS600C100-(*4 SS600C100-(*6

Note: (*)- 2 Is For 12 Gauge
4 Is For 14 Gauge
6 Is For 16 Gauge

Example: SS400C100-66
Denotes: 4" Wide X 2" Deep X 16 GA. X 316 S.S. Channel





Fittings: For 1" Deep Channel Channel Connector

Note: All illustrations are 2" wide channel

Channel Width	Aluminum	H.D.G.A.F.	Stainless
1"	A101CN	HG101CN	SS101CN
1-1/2"	A151CN	HG151CN	SS151CN
2"	A201CN	HG201CN	SS201CN
4"	A401CN	HG401CN	SS401CN
6"	A601CN	HG601CN	SS601CN

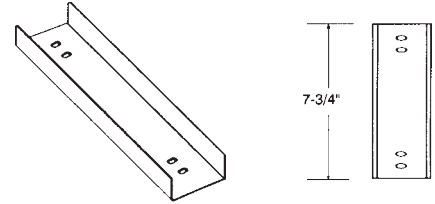

90° Channel Outside Vertical Elbow - 3" Radius

Channel Width	Aluminum	H.D.G.A.F.	Stainless
1"	A101COVE	HG101COVE	SS101COVE
1-1/2"	A151COVE	HG151COVE	SS151COVE
2"	A201COVE	HG201COVE	SS201COVE
4"	A401COVE	HG401COVE	SS401COVE
6"	A601COVE	HG601COVE	SS601COVE

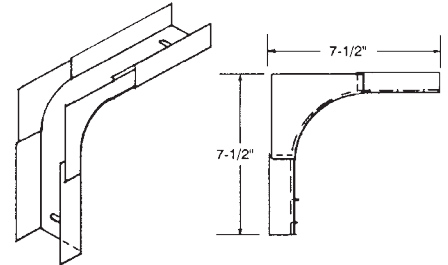

90° Channel Inside Vertical Elbow - 3" Radius

Channel Width	Aluminum	H.D.G.A.F.	Stainless
1"	A101CIVE	HG101CIVE	SS101CIVE
1-1/2"	A151CIVE	HG151CIVE	SS151CIVE
2"	A201CIVE	HG201CIVE	SS201CIVE
4"	A401CIVE	HG401CIVE	SS401CIVE
6"	A601CIVE	HG601CIVE	SS601CIVE

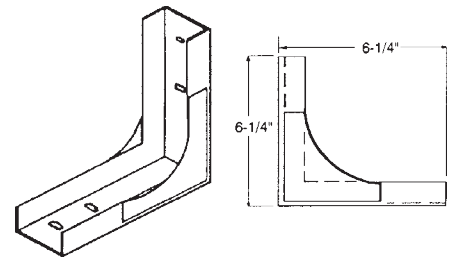

90° Channel Horizontal Elbow - 3" Radius

Channel Width	Aluminum	H.D.G.A.F.	Stainless
1"	A101CHE	HG101CHE	SS101CHE
1-1/2"	A151CHE	HG151CHE	SS151CHE
2"	A201CHE	HG201CHE	SS201CHE
4"	A401CHE	HG401CHE	SS401CHE
6"	A601CHE	HG601CHE	SS601CHE

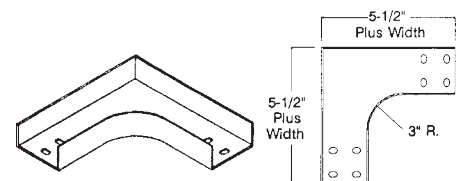



Fittings: For 1" Deep Channel

Channel Horizontal Cross - 3" Radius

Channel Width	Aluminum	H.D.G.A.F.	Stainless
1"	A101CHC	HG101CHC	SS101CHC
1-1/2"	A151CHC	HG151CHC	SS151CHC
2"	A201CHC	HG201CHC	SS201CHC
4"	A401CHC	HG401CHC	SS401CHC
6"	A601CHC	HG601CHC	SS601CHC

Note: All illustrations are 2" wide channel

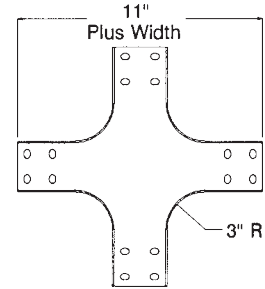

Channel Horizontal Tee - 3" Radius

Channel Width	Aluminum	H.D.G.A.F.	Stainless
1"	A101CHT	HG101CHT	SS101CHT
1-1/2"	A151CHT	HG151CHT	SS151CHT
2"	A201CHT	HG201CHT	SS201CHT
4"	A401CHT	HG401CHT	SS401CHT
6"	A601CHT	HG601CHT	SS601CHT

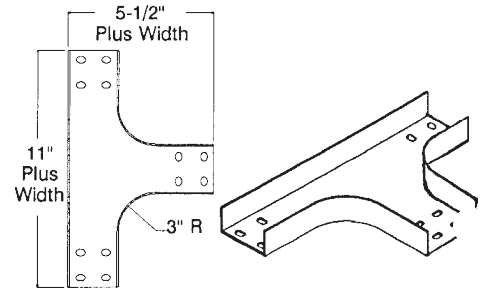

90° Channel Horizontal Elbow - 12" Radius

Channel Width	Aluminum	H.D.G.A.F.	Stainless
1"	A101CHE-12	HG101CHE-12	SS101CHE-12-4
1-1/2"	A151CHE-12	HG151CHE-12	SS151CHE-12-4
2"	A201CHE-12	HG201CHE-12	SS201CHE-12-4
4"	A401CHE-12	HG401CHE-12	SS401CHE-12-4
6"	A601CHE-12	HG601CHE-12	SS601CHE-12-4

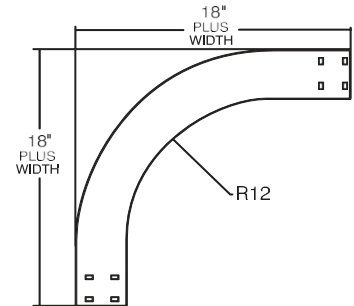

90° Channel Outside Vertical Elbow - 12" Radius

Channel Width	Aluminum	H.D.G.A.F.	Stainless
1"	A101COVE-12	HG101COVE-12	SS101COVE-12-4
1-1/2"	A151COVE-12	HG151COVE-12	SS151COVE-12-4
2"	A201COVE-12	HG201COVE-12	SS201COVE-12-4
4"	A401COVE-12	HG401COVE-12	SS401COVE-12-4
6"	A601COVE-12	HG601COVE-12	SS601COVE-12-4

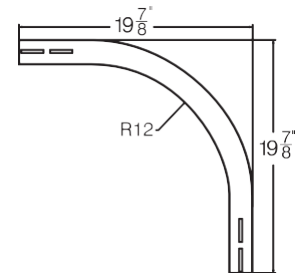



Fittings: For 1" Deep Channel

90° Channel Inside Vertical Elbow - 14" Radius

Channel Width	Aluminum	H.D.G.A.F.	Stainless
1"	A101CIVE-14	HG101CIVE-14	SS101CIVE-14-4
1-1/2"	A151CIVE-14	HG151CIVE-14	SS151CIVE-14-4
2"	A201CIVE-14	HG201CIVE-14	SS201CIVE-14-4
4"	A401CIVE-14	HG401CIVE-14	SS401CIVE-14-4
6"	A601CIVE-14	HG601CIVE-14	SS601CIVE-14-4

Note: All illustrations are 2" wide channel

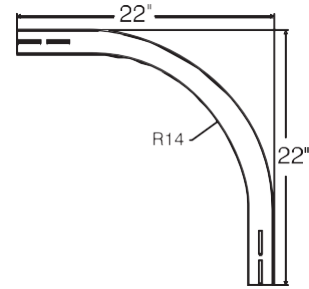

Channel Horizontal Tee - 12" Radius

Channel Width	Aluminum	H.D.G.A.F.	Stainless
1"	A101CHT-12	HG101CHT-12	SS101CHT-12-4
1-1/2"	A151CHT-12	HG151CHT-12	SS151CHT-12-4
2"	A201CHT-12	HG201CHT-12	SS201CHT-12-4
4"	A401CHT-12	HG401CHT-12	SS401CHT-12-4
6"	A601CHT-12	HG601CHT-12	SS601CHT-12-4

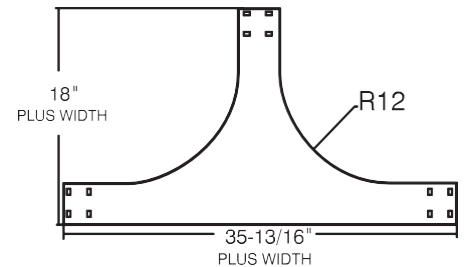

Channel Horizontal Cross - 12" Radius

Channel Width	Aluminum	H.D.G.A.F.	Stainless
1"	A101CHC-12	HG101CHC-12	SS101CHC-12-4
1-1/2"	A151CHC-12	HG151CHC-12	SS151CHC-12-4
2"	A201CHC-12	HG201CHC-12	SS201CHC-12-4
4"	A401CHC-12	HG401CHC-12	SS401CHC-12-4
6"	A601CHC-12	HG601CHC-12	SS601CHC-12-4

