

**A pre-engineered protective support system for: Single Tube • Multi-Tube • Electronic Cable**

**Round hole for 1/2" bolts  
Square hole for 1/4" carriage bolt or machine screw**

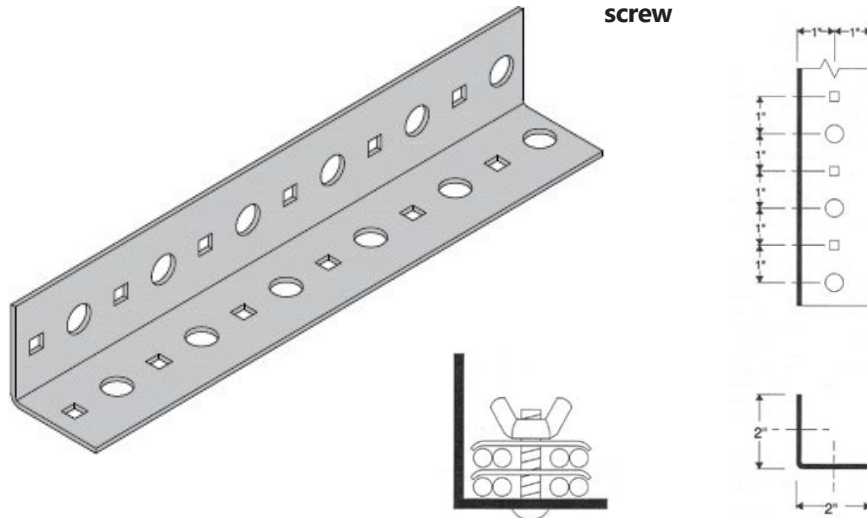

Lengths: 10 ft. & 20 ft.

(Option - Available punched on one leg only)

Dimensions	Material	Part Number
2" X 2" X 1/8"	6063-T6 Aluminum	A200A200
2" X 2" X 1/8"	H.D.G.A.F. Steel	HG200A200
2" X 2" X 12, 14, 16 ga.	304 Stainless Steel	SS200A200-(*)4
2" X 2" X 12, 14, 16 ga.	316 Stainless Steel	SS200A200-(*)6
2" X 2" X 1/8"	Fiberglass	FG200A200
3" X 3" X 1/8"	6063-T6 Aluminum	A300A300
3" X 3" X 1/8"	H.D.G.A.F. Steel	HG300A300
3" X 3" X 12, 14, 16 ga.	304 Stainless Steel	SS300A300-(*)4
3" X 3" X 12, 14, 16 ga.	316 Stainless Steel	SS300A300-(*)6
3" X 3" X 1/8"	Fiberglass	FG300A300

Note: **Insert 2 For (\*) For 12 Gauge**  
**Insert 4 For (\*) For 14 Gauge**  
**Insert 6 For (\*) For 16 Gauge**

**Complete Line of Fittings and Cable/Tubing Clamps are Available**





**Angle Fittings:**

2"

**Angle Connector**

Part #	Material
A200ACN	Aluminum
HG200ACN	H.D.G.A.F.
SS200ACN-4	T-304 S.S.
SS200ACN-6	T-316 S.S.

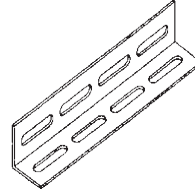
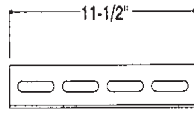

Part #	Material
A300ACN	Aluminum
HG300ACN	H.D.G.A.F.
SS300ACN-4	T-304 S.S.
SS300ACN-6	T-316 S.S.

2"

**90° Angle Inside Elbow, 3" Radius, Horiz./Vert.**

3"

Part #	Material
A200AIHE	Aluminum
HG200AIHE	H.D.G.A.F.
SS200AIHE-4	T-304 S.S.
SS200AIHE-6	T-316 S.S.

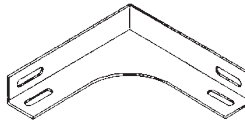
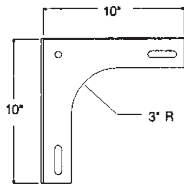

Part #	Material
A300AIHE	Aluminum
HG300AIHE	H.D.G.A.F.
SS300AIHE-4	T-304 S.S.
SS300AIHE-6	T-316 S.S.

2"

**90° Angle Outside Elbow, 3" Radius, Horiz./Vert.**

3"

Part #	Material
A200AOHE	Aluminum
HG200AOHE	H.D.G.A.F.
SS200AOHE-4	T-304 S.S.
SS200AOHE-6	T-316 S.S.

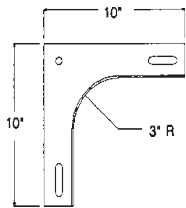

Part #	Material
A300AOHE	Aluminum
HG300AOHE	H.D.G.A.F.
SS300AOHE-4	T-304 S.S.
SS300AOHE-6	T-316 S.S.

2"

**90° Angle Outside Elbow, 12" Radius, Horiz./Vert.**

3"

Part #	Material
A200AOHE-12	Aluminum
HG200AOHE-12	H.D.G.A.F.
SS200AOHE-12-4	T-304 S.S.
SS200AOHE-12-6	T-316 S.S.

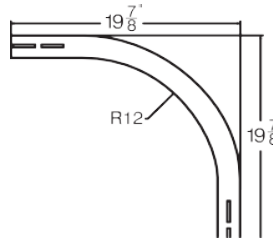

Part #	Material
A300AOHE-12	Aluminum
HG300AOHE-12	H.D.G.A.F.
SS300AOHE-12-4	T-304 S.S.
SS300AOHE-12-6	T-316 S.S.

2"

**90° Angle Inside Elbow, 14" Radius, Horiz./Vert.**

3"

Part #	Material
A200AIHE-14	Aluminum
HG200AIHE-14	H.D.G.A.F.
SS200AIHE-14-4	T-304 S.S.
SS200AIHE-14-6	T-316 S.S.

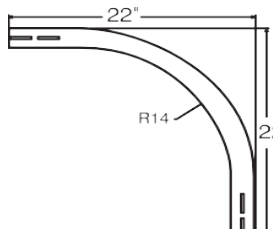

Part #	Material
A300AIHE-14	Aluminum
HG300AIHE-14	H.D.G.A.F.
SS300AIHE-14-4	T-304 S.S.
SS300AIHE-14-6	T-316 S.S.

